













***MATRIX BUILDING SYSTEM
PART / ACCESSORIE LIST***

Sensor, Module

Analog

MS-003V3	MATRIX Grayscale Sensor V3	
*MS-003V2	MATRIX Grayscale Sensor V2	
MS-013	MATRIX Potentiometer Sensor	
MS-014	MATRIX Water Level Sensor	
MS-016	MATRIX Soil Moisture Sensor	
*#28995	IR Range Sensor (10cm to 80cm)	

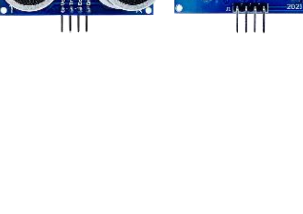
Digital

MS-004V3	MATRIX Miniature Switch V3	
*MS-004V2	MATRIX Miniature Switch V2	
MS-011	MATRIX Temperature & Humidity Sensor	
MS-012	MATRIX PIR Motion Sensor	
MS-015	MATRIX One Wire Temperature Sensor	
MS-019	MATRIX CAN bus module	
*#28015	PING Ultrasonic Distance Sensor	

I²C(A0)

*MS-001	MATRIX Motion Sensor	
MS-002V3	MATRIX Color Sensor V3	
*MS-002V2	MATRIX Color Sensor V2	
MS-009V2	MATRIX Laser Sensor V2	
*MS-009	MATRIX Laser Sensor	
MS-017	MATRIX Gesture Sensor	
MS-018V2	MATRIX Line Tracer 10CHV2	
*MS-018	MATRIX Line Tracer 10CH	
*BNO055	BNO055 Absolute Orientation IMU	

UART

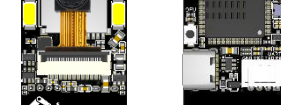
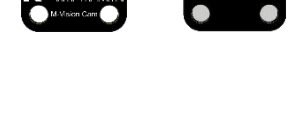
MS-010V2	M-Vision AI Cam V2	
*MS-010	M-Vision AI Cam	

Servo, Motor





RC Servo		DC Motor	Bracket and Accessory		
MRC-TB2-180	MATRIX RC Servo with Technic Brick Form	ME12DC-0001	MATRIX 12V DC High Torque Encoder Motor	07-0001	Micro Servo Bracket
MMRC-MG90S	MATRIX Micro Servo with metal gear box	ME12DC-0002	MATRIX 12V DC Middle Speed/Torque Encoder Motor	*07-0002	Servo Bracket
MRC-MG15-180	MATRIX RC Servo with metal gear box	ME12DC-0003	MATRIX 12V DC High Speed Encoder Motor	07-0009	RC Servo Bracket
MRC-MG25-180	MATRIX RC Servo with metal gear box	*GBP302-H-R/58	KNR 15V High Speed Motor	07-0005	DC Motor Double Flanged Bracket - 5 x 7 Hole
*MRC-MG17-335	MATRIX RC Servo with metal gear box	*GBP303-L-R/67	KNR 15V High Torque Motor	07-0011	DC Motor Hub Bracket
*MRC-MG360S	MATRIX RC Servo with metal gear box	*am-2964a	NeveRest Classic 40 Gearmotor Anderson Powerpole 15A	07-2331	DC Motor Double Flanged Bracket - 23 x 31 Hole
*MRC-MG996	MATRIX RC Servo with metal gear box	*am-3103	NeveRest Classic 60 Gearmotor Anderson Powerpole 15A	*07-AM3103	DC Motor Double Flanged Bracket – am3103
*MRC-MG6225-PDI	MATRIX RC Servo with metal gear box	*am-3637	NeveRest Orbital Gearmotors Anderson Powerpole 15A 19.2 to 1 (~334RPM)	*07-AM3637	DC Motor Double Flanged Bracket – am3637
TB / TT Motor		*14-0001	MATRIX 9V DC HS Motor	07-0004	Servo Bearing Beam - 5 Hole
*METB-SG001	MATRIX TB Encoder Medium Motor	*14-0009	MATRIX 9V DC HT Motor	07-0006	Servo Horn Wheel Brace - Short
METT-MG001	MATRIX TT Encoder Motor with metal gear box	*14-0011	MATRIX Motor with Anderson Powerpole	07-0007	Servo Horn Wheel Brace - Long
MTT-MG001	MATRIX TT Motor with metal gear box	*14-0015	MATRIX Motor with 6mm D Shaft	07-0008	TT Motor Bracket (Set of Left and Right)
MTT-SG001	MATRIX TT Motor			13-0012	Micro Servo Horn Wheel
				13-0002	RC Servo Horn Wheel

Beam, Plate



L Shaped Beam

01-0003	L Shaped Beam - 3 Hole	
01-0005	L Shaped Beam - 5 Hole	
01-0007	L Shaped Beam - 7 Hole	
01-0009	L Shaped Beam - 9 Hole	
01-0021	L Shaped Beam - 21 Hole	
01-0029	L Shaped Beam - 29 Hole	
01-0037	L Shaped Beam - 37 Hole	
01-0313	L Shaped Beam XL - 13 Hole	
01-0317	L Shaped Beam XL - 17 Hole	
01-0321	L Shaped Beam XL - 21 Hole	
01-0329	L Shaped Beam XL - 29 Hole	
01-0337	L Shaped Beam XL - 37 Hole	
01-0349	L Shaped Beam XL - 49 Hole	





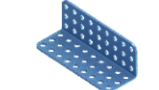
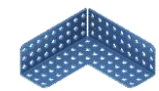
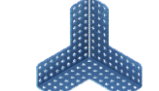

Flat Beam

02-0003	Flat Beam - 3 Hole	
02-0005	Flat Beam - 5 Hole	
02-0007	Flat Beam - 7 Hole	
02-0009	Flat Beam - 9 Hole	
02-0011	Flat Beam - 11 Hole	

Beam Joiner

03-0001	Beam Joiner - 1D Straight	
03-0002	Beam Joiner - 2D Right Angle	
03-0003	Beam Joiner - 3D Right Angle	
03-0301	Beam Joiner XL - 1D Straight	
03-0302	Beam Joiner XL - 2D Right Angle	
03-0303	Beam Joiner XL - 3D Right Angle	

Gusset Plate

04-0303	Gusset Plate 3 x 3 Hole	
04-0305	Gusset Plate 3 x 5 Hole	
04-0307	Gusset Plate 3 x 7 Hole	
04-0309	Gusset Plate 3 x 9 Hole	
04-0505	Gusset Plate 5 x 5 Hole	
04-0921	Gusset Plate 9 x 21 Hole	



Special Plate

17-0709	Triangle Plate 6-8-10 Hole	
---------	----------------------------	---





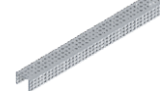

























Flanged Plate

05-0303	Flanged Plate 3 x 3 Hole	
05-0305	Flanged Plate 3 x 5 Hole	
05-0307	Flanged Plate 3 x 7 Hole	
05-0309	Flanged Plate 3 x 9 Hole	



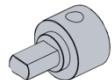
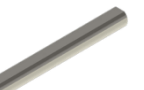































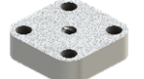



C Shaped Beam

06-0005	C Shaped Beam - 5 Hole	
06-0009	C Shaped Beam - 9 Hole	
06-0013	C Shaped Beam - 13 Hole	
06-0017	C Shaped Beam - 17 Hole	
06-0021	C Shaped Beam - 21 Hole	
06-0029	C Shaped Beam - 29 Hole	
06-0037	C Shaped Beam - 37 Hole	
06-0049	C Shaped Beam - 49 Hole	
06-0339	C Shaped Beam XL - 39 Hole	
06-0347	C Shaped Beam XL - 47 Hole	
06-2232	C Shaped Beam XL2 - 232mm	
06-2296	C Shaped Beam XL2 - 296mm	
06-2424	C Shaped Beam XL2 - 424mm	
*06-2216	C Shaped Beam XL2 - 216mm	
*06-2312	C Shaped Beam XL2 - 312mm	
*06-2408	C Shaped Beam XL2 - 408mm	







































Shaft, Adaptor

<i>D Shaft</i>		<i>Joiner and Collar</i>		<i>Hub</i>		<i>Bearing Tube</i>					
10-0028	4mm D Shaft - 28mm		08-0019	4mm Axle Collar with M4 set screw		08-0006	4mm Omni Flat Wheel Nut		08-0015	4mm Bearing Tube - 15mm	
10-0052	4mm D Shaft - 52mm		08-0021	4mm to 4mm Coupling with M4 set screw		08-0024	4mm Omni Thin Wheel with M4 set screw		08-0030	4mm Bearing Tube - 30mm	
10-0080	4mm D Shaft - 80mm		08-0020	4mm to 6mm Adaptor with M4 set screw		08-0007	4mm Hub with M4 set screw		08-0018	6mm Bearing Tube - 15mm	
10-0132	4mm D Shaft - 132mm		08-0037 *08-0031	4mm to TT Adapter with M4 set screw		08-0014	6mm Omni Flat Wheel Nut		08-0017	6mm Bearing Tube - 30mm	
10-0160	4mm D Shaft - 160mm		08-0032	6mm Axle Collar with M4 set screw		08-0013	6mm Omni Thin Wheel with M4 set screw				
10-0164	4mm D Shaft - 164mm		08-0033	6mm to 6mm Coupling with M4 set screw		08-0008	6mm Hub with M4 set screw				
10-0280	4mm D Shaft - 280mm		09-0004	4mm Joiner Block with M3 set screw		08-0039	6mm Flanged Ball Bearing				
10-6030	6mm D Shaft - 30mm		08-0036	4mm TT Shaft Adapter with M4 set screw							
10-6050	6mm D Shaft - 50mm										
10-6080	6mm D Shaft - 80mm										
10-6160	6mm D Shaft - 160mm										
10-6300	6mm D Shaft - 300mm										

Power Transmission, Wheel

Gear		Chain Kit		Linear Slide		Wheel		
12-0024	Gear - 24 Tooth with M4 set screw		*#25-1X240 Roller Chain 25 x 240 Link		12-0001 Tooth Belt - 7 Hole		13-0003 Caster Wheel - 48mm	
12-0040	Gear - 40 Tooth with M4 set screw		#25-1X480 Roller Chain 25 x 480 Link		12-0002 Linear Slide - 3 Hole		13-0001 Wheel - 96mm with M3 set screw	
12-0056	Gear - 56 Tooth with M4 set screw		A025016 25A Chain Gear - 16 Tooth		12-0003 Ball Slide		13-0009 Wide Wheel - 79mm	
13-0024	Metal Gear - 24 Tooth		A025024 25A Chain Gear - 24 Tooth		MGN09H HIWIN Miniature Guides MGN HIRES Series		13-0008 Single Omni Wheel - 94mm	
13-0040	Metal Gear - 40 Tooth		A025032 25A Chain Gear - 32 Tooth		MGN15H HIWIN Miniature Guides MGN HIRES Series		16-0001 4mm Double Omni Wheel - 94mm	
13-0056	Metal Gear - 56 Tooth						16-0002 6mm Double Omni Wheel - 94mm	
13-0104	Metal Gear - 104 Tooth						13-0013 6mm Mecanum Wheel - 100mm	
			Synchronous Wheel		Leadscrew			
			2GT-20T 2GT Synchronous Wheel - 20 Tooth		18-0001 Leadscrew Block		13-0014 6mm Mecanum Wheel - 203mm	
			2GT-36T 2GT Synchronous Wheel - 36 Tooth		18-0128 Leadscrew - 128mm		13-0015 6mm Plastic Mecanum Wheel - 100mm	
			2GT-48T 2GT Synchronous Wheel - 48 Tooth		18-0256 Leadscrew - 256mm			
			2GT-172-6 2GT Synchronous Belt - 172 x 6mm				TT-TIRE_OR MATRIX TT Wheel (Off-Road)	
			2GT-852-6 2GT Synchronous Belt - 852 x 6mm		21-0064 Rubber Band #64 - Synthetic		TT-TIRE_B MATRIX TT Wheel (Blue Rim)	
					21-0164 Rubber Band #64 - Silicone		13-0010 MATRIX Steel Ball Caster	

Connector, Tool

Screw		Nut		Ball and Socket Linkage		Tool					
11-3204	M3 Flat Point set screw - 4.5mm		11-4501	M4 Hex Nut		19-0036	Ball & Socket Linkage - 36mm		15-0001	MATRIX Quick Connector Staple	
11-3404	M4 Flat Point set screw - 4mm		11-4502	M4 Hex Nut with Tooth Washer		19-0052	Ball & Socket Linkage - 52mm		8020P-2	2mm Hex Wrench and Crosshead Screwdriver	
11-3104	M3 Button Head Screw - 4mm		11-4503	M4 Hex Nut with Nylon Lock		19-0068	Ball & Socket Linkage - 68mm		8020P-4	Hex Wrench and Crosshead Screwdriver Kit	
11-3106	M3 Button Head Screw - 6mm		11-6000	MATRIX Quick Connector – Battery Box		19-0128	Ball & Socket Linkage - 128mm		MTL-K1	MATRIX Tool - Kit 1	
11-3108	M3 Button Head Screw - 8mm		11-6050	MATRIX Quick Connector - 5mm		Washer / Spacer			*8020P-1	Crosshead Screwdriver	
11-4106	M4 Button Head Screw - 6mm		11-6070	MATRIX Quick Connector - 7mm		11-4402	M4 Nylon Washer		*HEXWRENCH M4	L Shaped M4 Hex Wrench	
11-4108	M4 Button Head Screw - 8mm		11-6120	MATRIX Quick Connector - 12mm		11-4403	M4 Nylon Shoulder Washer		*50-0015	Tool Kit	
11-4112	M4 Button Head Screw - 12mm		11-7050	MATRIX ML Quick Connector - 5mm		09-0003	M4 Standoff Spacer - 16mm				
11-4116	M4 Button Head Screw - 16mm					09-0001	M4 Standoff Spacer - 32mm				
11-4120	M4 Button Head Screw - 20mm					13-0005	Spacer - 4mm				
11-4124	M4 Button Head Screw - 24mm					13-0004	Spacer - 8mm				
11-4140	M4 Button Head Screw - 40mm										
*11-3608	M3 Cylinder Head Screw - 8mm										
*11-4604	M4 Cylinder Head Screw - 4mm	