

























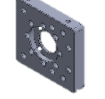

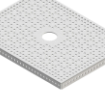







***MATRIX BUILDING SYSTEM  
PART LIST***

## Controller, Sensor, Joystick, Panel

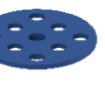
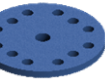

Controller		Motor Controller		Sensor	
MMJ-000	MATRIX Micro Junior Controller	14-0004	MATRIX Motor Controller - 12V	MS-001	MATRIX Motion Sensor
MM-000 V2	MATRIX Micro Controller V2	*14-0003	MATRIX Motor Controller - 9V	MS-002V2	MATRIX Color Sensor V2
MR-000 V2-4	MATRIX Mini Controller V2.4	<b>Joystick</b>		MS-003V2	MATRIX Grayscale Sensor V2
MA-000	MATRIX Mini R4 Controller	MJ2	MATRIX JOYSTICK II	MS-004V2	MATRIX Miniature Switch V2
*KNR-MBS0214	KNRm Controller	<b>Camera</b>		MS-009	MATRIX Laser Sensor
		MS-010	M-Vision AI Cam	*#28015	PING Ultrasonic Distance Sensor
		<b>Control Panel</b>		*#28995	IR Range Sensor (10cm to 80cm)
		MP-001	MATRIX Emergency Switch Module	*BON055	BON055 Absolute Orientation IMU

## Servo, Motor





Servo			DC Motor			Bracket and Accessory		
MMRC-MG90S	MATRIX Micro Servo with metal gear box		ME12DC-0001	MATRIX 12V DC High Speed Encoder Motor		07-0001	Micro Servo Bracket	
MRC-MG25-180	MATRIX RC Servo with metal gear box		ME12DC-0002	MATRIX 12V DC Middle Speed/Torque Encoder Motor		*07-0002	Servo Bracket	
*MRC-MG17-335	MATRIX RC Servo with metal gear box		ME12DC-0003	MATRIX 12V DC High Torque Encoder Motor		07-0009	RC Servo Bracket	
*MRC-MG360S	MATRIX RC Servo with metal gear box		GBP302-H-R/58	KNR 15V High Speed Motor		07-0005	DC Motor Double Flanged Bracket - 5 x 7 Hole	
*MRC-MG996	MATRIX RC Servo with metal gear box		GBP303-L-R/67	KNR 15V High Torque Motor		07-0010	DC Motor Hub Bracket	
*MRC-MG6225-PDI	MATRIX RC Servo with metal gear box		am-2964a	NeveRest Classic 40 Gearmotor Anderson Powerpole 15A		07-2331	DC Motor Double Flanged Bracket - 23 x 31 Hole	
<b>TT Motor</b>			am-3103	NeveRest Classic 60 Gearmotor Anderson Powerpole 15A		07-AM3103	DC Motor Double Flanged Bracket – am3103	
METT-MG001	MATRIX TT Encoder Motor with metal gear box		am-3637	NeveRest Orbital Gearmotors Anderson Powerpole 15A 19.2 to 1 (~334RPM)		07-AM3637	DC Motor Double Flanged Bracket – am3637	
MTT-MG001	MATRIX TT Motor with metal gear box		*14-0001	MATRIX 9V DC HS Motor		07-0004	Servo Bearing Beam - 5 Hole	
MTT-SG001	MATRIX TT Motor		*14-0009	MATRIX 9V DC HT Motor		07-0006	Servo Horn Wheel Brace - Short	
			*14-0011	MATRIX Motor with Anderson Powerpole		07-0007	Servo Horn Wheel Brace - Long	
			*14-0015	MATRIX Motor with 6mm D Shaft		07-0008	TT Motor Bracket (Set of Left and Right)	
						13-0012	Micro Servo Horn Wheel	
						13-0002	RC Servo Horn Wheel	

## Beam, Plate





### L Shaped Beam

01-0003	L Shaped Beam - 3 Hole	
01-0005	L Shaped Beam - 5 Hole	
01-0007	L Shaped Beam - 7 Hole	
01-0009	L Shaped Beam - 9 Hole	
01-0021	L Shaped Beam - 21 Hole	
01-0029	L Shaped Beam - 29 Hole	
01-0037	L Shaped Beam - 37 Hole	
01-0313	L Shaped Beam XL - 13 Hole	
01-0317	L Shaped Beam XL - 17 Hole	
01-0321	L Shaped Beam XL - 21 Hole	
01-0329	L Shaped Beam XL - 29 Hole	
01-0337	L Shaped Beam XL - 37 Hole	
01-0349	L Shaped Beam XL - 49 Hole	





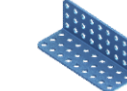
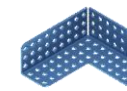

### Flat Beam

02-0003	Flat Beam - 3 Hole	
02-0005	Flat Beam - 5 Hole	
02-0007	Flat Beam - 7 Hole	
02-0009	Flat Beam - 9 Hole	
02-0011	Flat Beam - 11 Hole	

### Beam Joiner

03-0001	Beam Joiner - 1D Straight	
03-0002	Beam Joiner - 2D Right Angle	
03-0003	Beam Joiner - 3D Right Angle	
03-0301	Beam Joiner XL - 1D Straight	
03-0302	Beam Joiner XL - 2D Right Angle	
03-0303	Beam Joiner XL - 3D Right Angle	

### Gusset Plate

04-0303	Gusset Plate 3 x 3 Hole	
04-0305	Gusset Plate 3 x 5 Hole	
04-0307	Gusset Plate 3 x 7 Hole	
04-0309	Gusset Plate 3 x 9 Hole	
04-0505	Gusset Plate 5 x 5 Hole	
04-0921	Gusset Plate 9 x 21 Hole	

### Special Plate

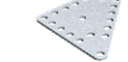
17-0709	Triangle Plate 6-8-10 Hole	
---------	----------------------------	---













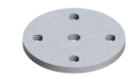

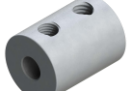













### Flanged Plate

05-0303	Flanged Plate 3 x 3 Hole	
05-0305	Flanged Plate 3 x 5 Hole	
05-0307	Flanged Plate 3 x 7 Hole	
05-0309	Flanged Plate 3 x 9 Hole	

### C Shaped Beam

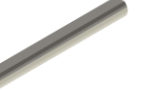
06-0005	C Shaped Beam - 5 Hole	
06-0009	C Shaped Beam - 9 Hole	
06-0013	C Shaped Beam - 13 Hole	
06-0017	C Shaped Beam - 17 Hole	
06-0021	C Shaped Beam - 21 Hole	
06-0029	C Shaped Beam - 29 Hole	
06-0037	C Shaped Beam - 37 Hole	
06-0049	C Shaped Beam - 49 Hole	
06-0339	C Shaped Beam XL - 39 Hole	
06-0347	C Shaped Beam XL - 47 Hole	
06-2232	C Shaped Beam XL2 - 232mm	
06-2296	C Shaped Beam XL2 - 296mm	
06-2424	C Shaped Beam XL2 - 424mm	
*06-2216	C Shaped Beam XL2 - 216mm	
*06-2312	C Shaped Beam XL2 - 312mm	
*06-2408	C Shaped Beam XL2 - 408mm	

## Shaft, Adaptor

<i>D Shaft</i>		<i>Joiner and Coller</i>		<i>Hub</i>		<i>Bearing Tube</i>					
10-0028	4mm D Shaft - 28mm		08-0019	4mm Axle Collar with M4 set screw		08-0006	4mm Omni Flat Wheel Nut		08-0015	4mm Bearing Tube - 15mm	
10-0052	4mm D Shaft - 52mm		08-0021	4mm to 4mm Coupling with M4 set screw		08-0024	4mm Omni Thin Wheel with M4 set screw		08-0030	4mm Bearing Tube - 30mm	
10-0080	4mm D Shaft - 80mm		08-0020	4mm to 6mm Adaptor with M4 set screw		08-0007	4mm Hub with M4 set screw		08-0018	6mm Bearing Tube - 15mm	
10-0132	4mm D Shaft - 132mm		*08-0031	4mm to TT Adapter with M4 set screw		08-0014	6mm Omni Flat Wheel Nut		08-0017	6mm Bearing Tube - 30mm	
10-0160	4mm D Shaft - 160mm		08-0037	4mm to TT Adapter with M4 set screw		08-0013	6mm Omni Thin Wheel with M4 set screw				
10-0164	4mm D Shaft - 164mm		08-0032	6mm Axle Collar with M4 set screw		08-0008	6mm Hub with M4 set screw				
10-0280	4mm D Shaft - 280mm		08-0033	6mm to 6mm Coupling with M4 set screw							
10-6030	6mm D Shaft - 30mm		09-0004	4mm Joiner Block with M3 set screw							
10-6050	6mm D Shaft - 50mm										
10-6080	6mm D Shaft - 80mm										
10-6160	6mm D Shaft - 160mm										
10-6300	6mm D Shaft - 300mm										



## Gear, Wheel

Gear		Linear Slide		Chain Kit		Wheel	
12-0024	Gear - 24 Tooth with M4 set screw	12-0001	Tooth Belt - 7 Hole	*#25-1X240	Roller Chain 25 x 240 Link	13-0003	Caster Wheel - 48mm
12-0040	Gear - 40 Tooth with M4 set screw	12-0002	Linear Slide - 3 Hole	#25-1X480	Roller Chain 25 x 480 Link	13-0001	Wheel - 96mm with M3 set screw
12-0056	Gear - 56 Tooth with M4 set screw	MGN09H	HIWIN Miniature Guides MGN HIRES Series	A025016	25A Chain Gear - 16 Tooth	13-0009	Wide Wheel - 79mm
13-0024	Metal Gear - 24 Tooth	MGN15H	HIWIN Miniature Guides MGN HIRES Series	A025024	25A Chain Gear - 24 Tooth	13-0008	Single Omni Wheel - 94mm
13-0040	Metal Gear - 40 Tooth	<b>Leadscrew</b>		A025032	25A Chain Gear - 32 Tooth	16-0001	4mm Double Omni Wheel - 94mm
13-0056	Metal Gear - 56 Tooth	18-0001	Leadscrew Block	<b>Synchronous Wheel</b>		16-0002	6mm Double Omni Wheel - 94mm
13-0104	Metal Gear - 104 Tooth	18-0128	Leadscrew - 128mm	2GT-36T	2GT Synchronous Wheel - 36 Tooth	13-0013	6mm Mecanum Wheel - 100mm
		18-0256	Leadscrew - 256mm	2GT-20T	2GT Synchronous Wheel - 20 Tooth	13-0014	6mm Mecanum Wheel - 203mm
		<b>Lift Module</b>		2GT-48T	2GT Synchronous Wheel - 48 Tooth	13-0015	6mm Plastic Mecanum Wheel - 100mm
		20-0040	Precision Linear Lift Module – 400mm	2GT-852-6	2GT Synchronous Belt - 852 x 6mm	TT-TIRE_OR	MATRIX TT Wheel (Off-Road)
				2GT-172-6	2GT Synchronous Belt - 172 x 6mm	TT-TIRE_B	MATRIX TT Wheel (Blue Rim)
						13-0010	MATRIX Steel Ball Caster

## Connector, Washer, Spacer

Screw		Nut		Ball and Socket Linkage		Washer	
11-3104	M3 Botton Head Screw - 4mm	11-4501	M4 Hex Nut	19-0036	Ball & Socket Linkage - 36mm	11-4402	M4 Nylon Washer
11-3106	M3 Botton Head Screw - 6mm	11-4502	M4 Hex Nut with Tooth Washer	19-0052	Ball & Socket Linkage - 52mm	11-4403	M4 Nylon Shoulder Washer
11-3115	M3 Botton Head Screw - 15mm	11-4503	M4 Hex Nut with Nylon Lock	19-0068	Ball & Socket Linkage - 68mm	<b>Spacer</b>	
11-3204	M3 Flat Point set screw - 4.5mm	11-6050	MATRIX Quick Connector - 5mm	19-0128	Ball & Socket Linkage - 128mm		
11-3404	M4 Flat Point set screw - 4mm	11-6070	MATRIX Quick Connector - 7mm		09-0003		
11-4104	M4 Botton Head Screw - 4mm	11-6120	MATRIX Quick Connector - 12mm			09-0001	M4 Standoff Spacer - 32mm
11-4108	M4 Botton Head Screw - 8mm	<b>Rubber Parts</b>				13-0005	Spacer - 4mm
11-4112	M4 Botton Head Screw - 12mm			21-0064	Rubber Band #64 - Synthetic		
11-4116	M4 Botton Head Screw - 16mm	21-0164	Rubber Band #64 - Silicone				
11-4120	M4 Botton Head Screw - 20mm						
11-4124	M4 Botton Head Screw - 24mm						
11-4140	M4 Botton Head Screw - 40mm						
*11-3015	M3 Phillips Screw - 15mm						